



# 3DMC Instruction Guide

## Excavator

SOFTWARE VERSION: 15



**> SOLUTION READY**

Advise | Enable | Support

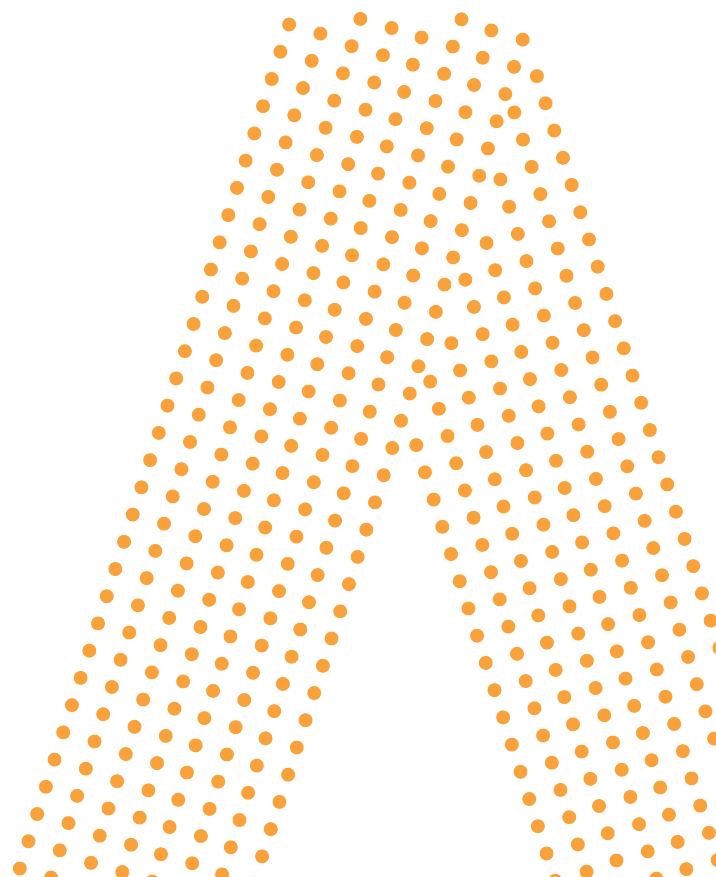

## Foreword

This course is designed to fulfil the needs of users from the surveying, mining and civil industry and has been produced by Aptella. Its contents are informed by many decades of experience in surveying, civil engineering, and related applications, coupled with technical expertise from manufacturer-trained employees. In addition, we acknowledge the input from our customers and former students by assisting us with feedback on the contents of this course.

Copyright © Aptella Pty Ltd, Melbourne, 2024. This training guide is available for personal use only. It is not to be reproduced in any form, redistributed, or sold without the express permission of Aptella. Any queries regarding the commercial availability of this training guide should be directed to Aptella.

## Aptella Technical Support

QR Code for Online Resources (Quick Guides, Videos, Manuals)



### Technical Support Contact Details

This number will connect you to the closest branch for Technical Support.

**AUS National Support Number      1300 867 266 (Option 1)**

**NZ National Support Number      0800 267 266 (Option 1)**

If you are unable to reach our regional support teams, please leave a voicemail so a support ticket is generated in our system. Our support team will get back to you as soon as possible to help with your inquiry.



# Contents

Foreword	2
<b>Aptella Technical Support</b>	<b>2</b>
QR Code for Online Resources (Quick Guides, Videos, Manuals)	2
Technical Support Contact Details	2
<b>Equipment Layout</b>	<b>5</b>
Excavator Schematic	5
<b>Overview of Display Interface</b>	<b>6</b>
Excavator Interface	6
<b>Main Menus and Shortcuts</b>	<b>7</b>
Main Menu Buttons	7
Shortcut Options & Customisation in 3DMC	8
<b>View &amp; Display Functions</b>	<b>9</b>
Changing Screen Layout Display	9
Adding and Changing Display Text	10
<b>Loading &amp; Selecting a Site</b>	<b>11</b>
Selecting a Site	11
Copying a Site	12
Selecting an Active Surface	13
<b>Coordinate System Configuration</b>	<b>14</b>
Applying a Localization to the Project	14
Applying a Projection & Geoid to the Project	15
<b>Elevation Set Point</b>	<b>16</b>
Applying a Vertical Offset	16
Steering to Line/Alignment	17
<b>Attachment (Bucket) Selection &amp; Wear</b>	<b>18</b>
Editing/Selecting Attachments	18
Implement (Cutting Edge) Wear Adjustment	18
<b>Position Check</b>	<b>19</b>
Checking Blade or Bucket Position	19
<b>GNSS Configuration &amp; Setup</b>	<b>20</b>
Setting up Radio/Network Configuration	20
GNSS Information and Status	21



<b>LPS Interface &amp; Setup</b>	<b>22</b>
<b>LPS Interface and Home/Search Functions</b>	<b>22</b>
<b>Initial Instruction Record</b>	<b>23</b>
<b>Notes</b>	<b>24</b>



# Equipment Layout

## Excavator Schematic

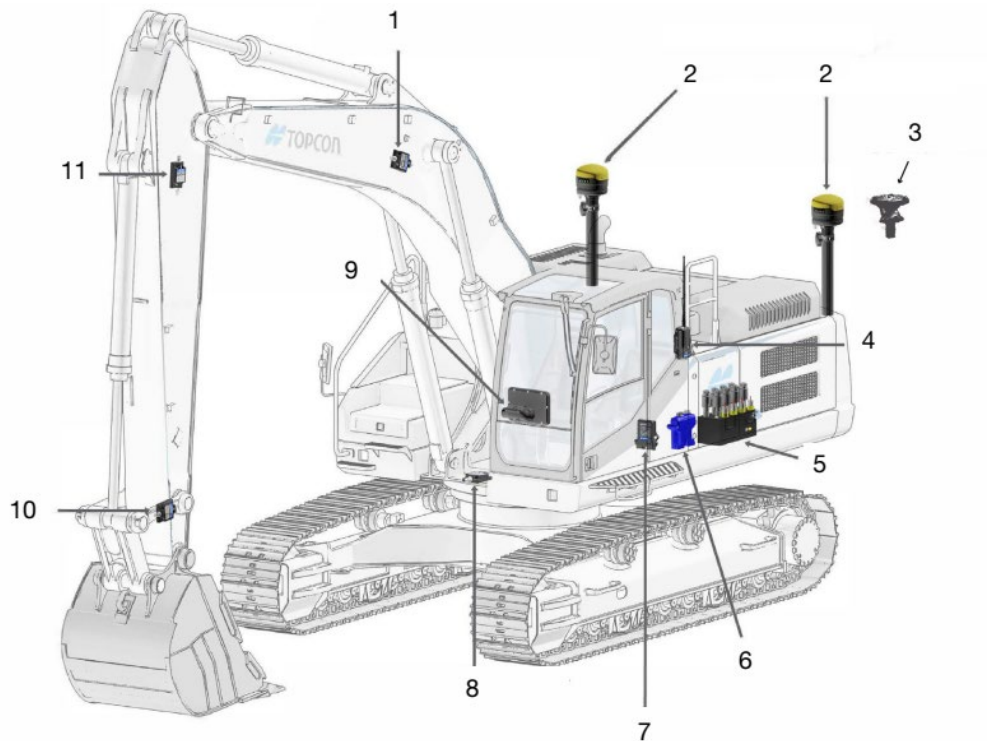
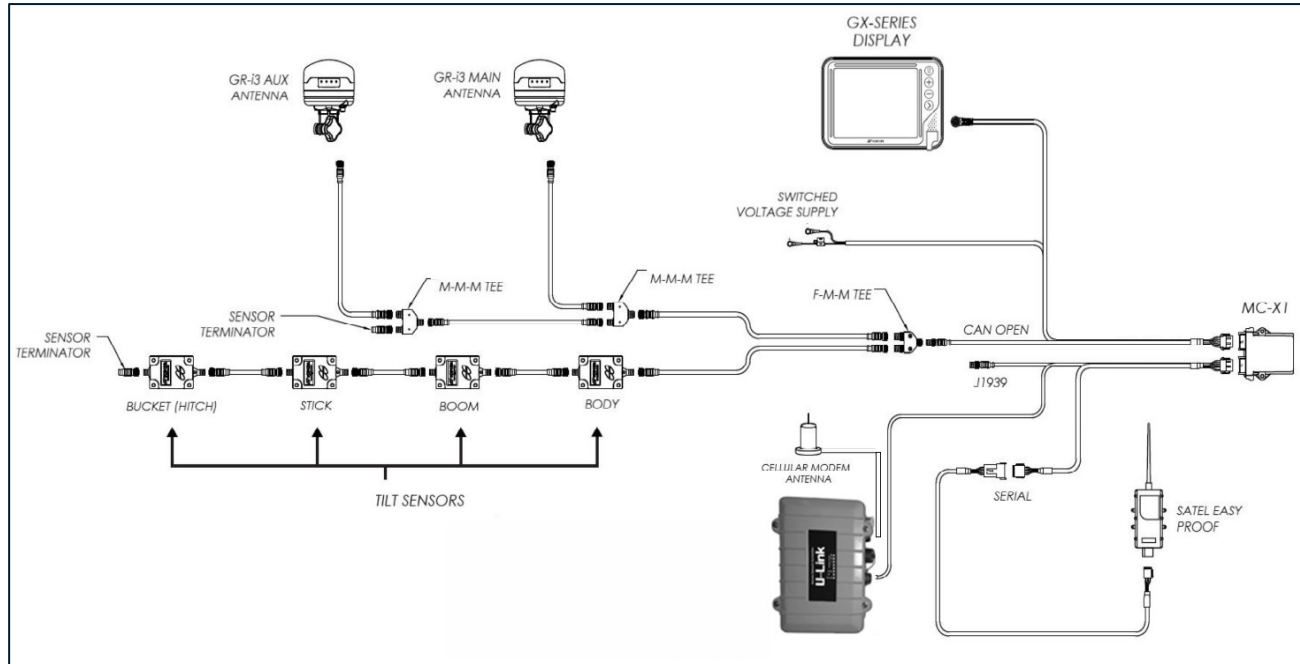

- |                       |                            |                         |                       |
|-----------------------|----------------------------|-------------------------|-----------------------|
| 1 TS-i4 Sensor - Boom | 2 GNSS Receiver            | 3 Machine Control Prism | 4 Radio Module        |
| 5 Control Manifold    | 6 Danfoss Controller       | 7 MC-X1 Controller      | 8 TS-i4 Sensor - Body |
| 9 GX-Series Display   | 10 TS-i4 Sensor - Dog Bone | 11 TS-i4 Sensor - Stick |                       |



## Overview of Display Interface

### Excavator Interface

This section provides an overview of the Excavator 3DMC user Interface.

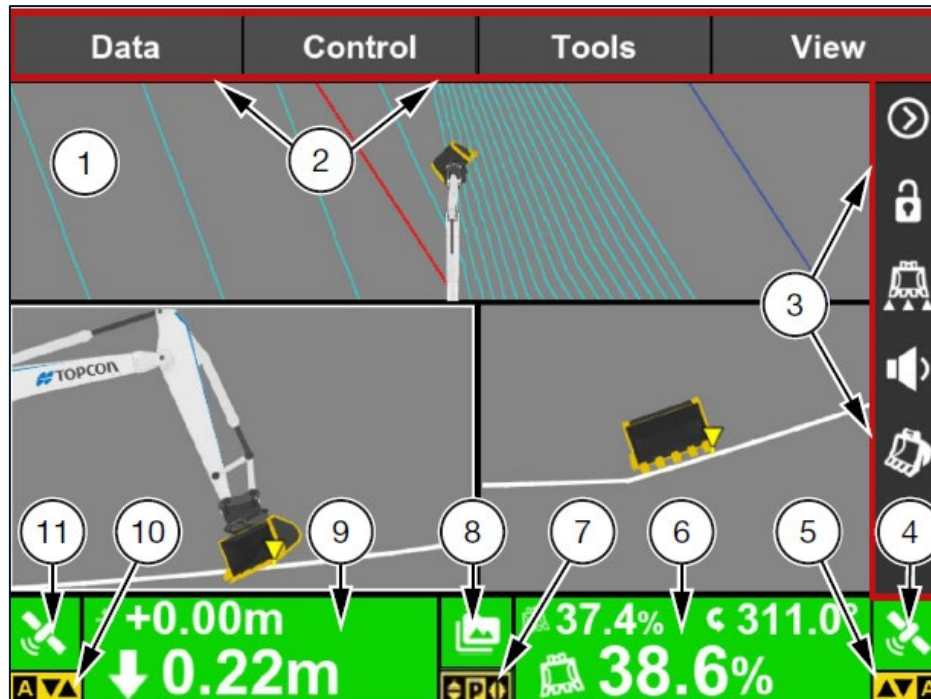

ID	USER INTERFACE COMPONENT	DESCRIPTION
1	Main Screen	Excavator user interface with configurable layout
2	Main Menu	Top level menu
3	Shortcut Ribbon	Shortcut buttons are a quick way to enable, disable, or change the functionality of an option. Frequently used icons are displayed as icons
4	2D/3D Elevation Type & Status Indicator	Indicates the current mode of operation and connection status
5	Bucket Mode Indicator	Yellow background indicates <b>BUCKET MODE</b> is engaged
6	Slope Control Button	Displays the slope and rotation of the blade. Opens the <b>Adjust Slope</b> screen
7	Protect Indicator	Yellow background indicates <b>PROTECT</b> is engaged
8	Site Type & Status Button/Indicator	Opens the <b>Sites</b> menu and displays icons that represent the status of the active site
9	Elevation Control Button	Displays cut/fill information and offsets. Opens the <b>Adjust Elevation</b> screen
10	AUTO Indicator	Yellow background indicates <b>AUTO</b> is engaged
11	2D/3D Elevation Type & Status Indicator	Indicates the current mode of operation and connection status



## Main Menu and Shortcuts

### Main Menu Buttons

In the **Data** menu you can manage and create site data, create and edit layers, and select or de-select active surfaces or alignments.

In the **Control** menu you can create, edit, copy, and delete machine setup files, add and calibrate blade/attachments, and enable 2D control.

The **Tools** menu contains options for configuring the radio, collecting and navigating to points, and checking the position of the blade/attachment.

In the **View** menu you can adjust your main screen view layout, select display options for surfaces and points, change how the machine image appears in the main screen, and add/remove shortcut buttons.

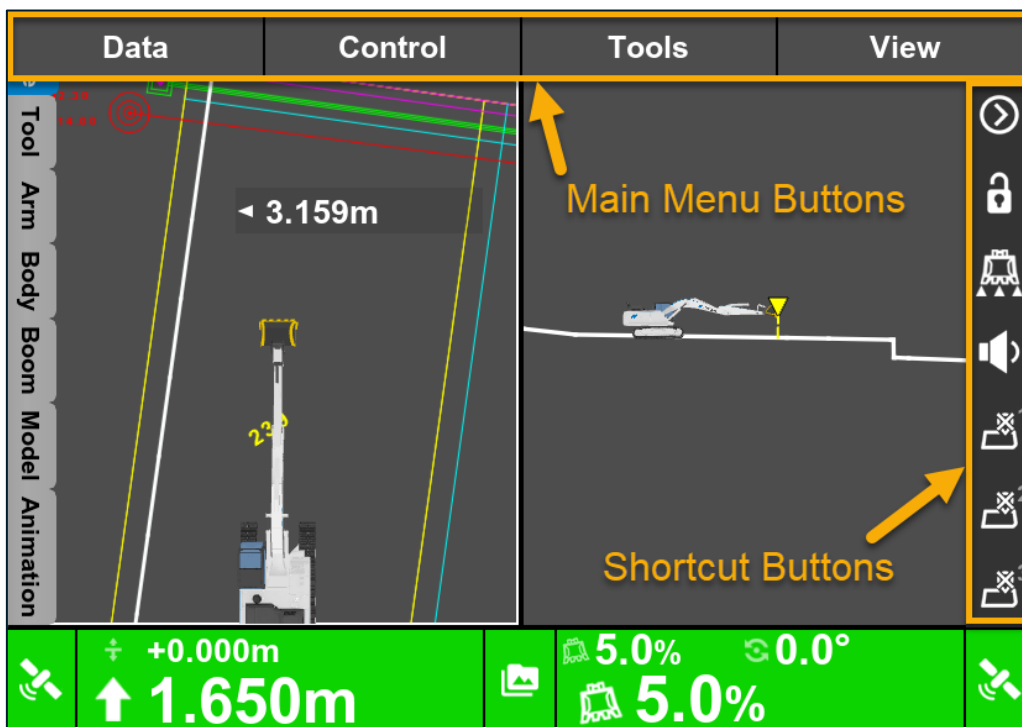

## Shortcut Options & Customisation in 3DMC

Shortcuts now occupy the right-hand side of the screen. Users now can toggle shortcuts on/off and order them as desired (the most commonly used shortcuts should be at the top).

Select **View** from the **Main Menu**, then tap on **Display Options** to access the **Shortcuts** button.

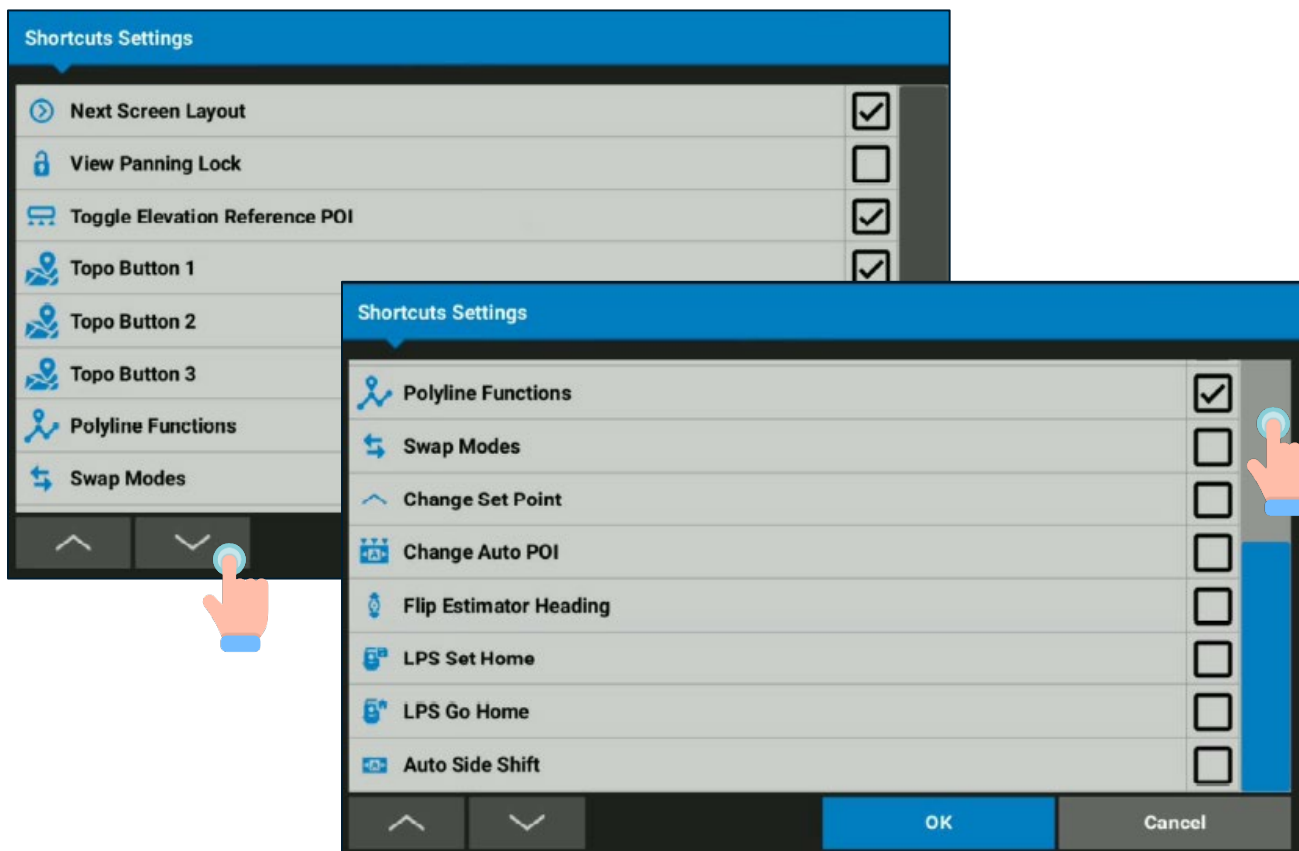
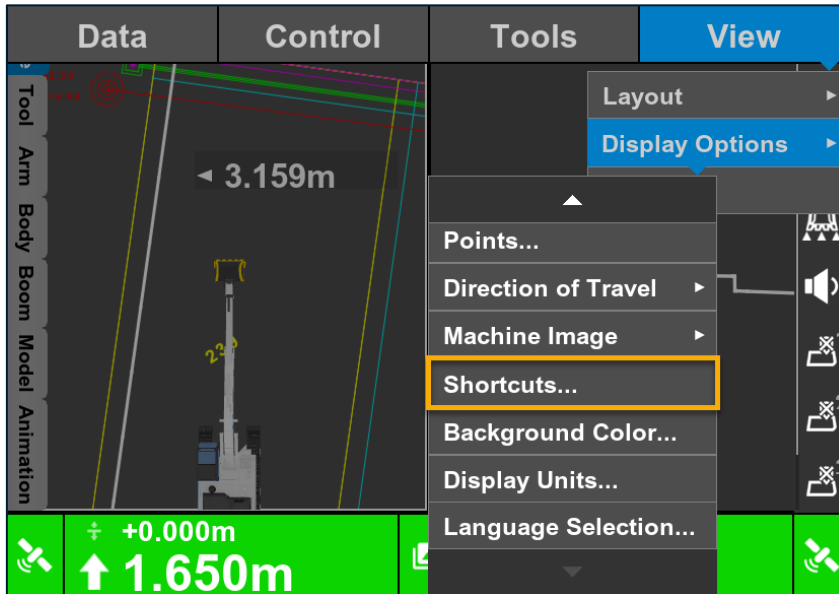

## View & Display Functions

### Changing Screen Layout Display

The main screen can be set to different layout configurations to suit the needs of the operator.

1. Select **View**
2. Select **layout**
3. Select either **New** or **Edit**

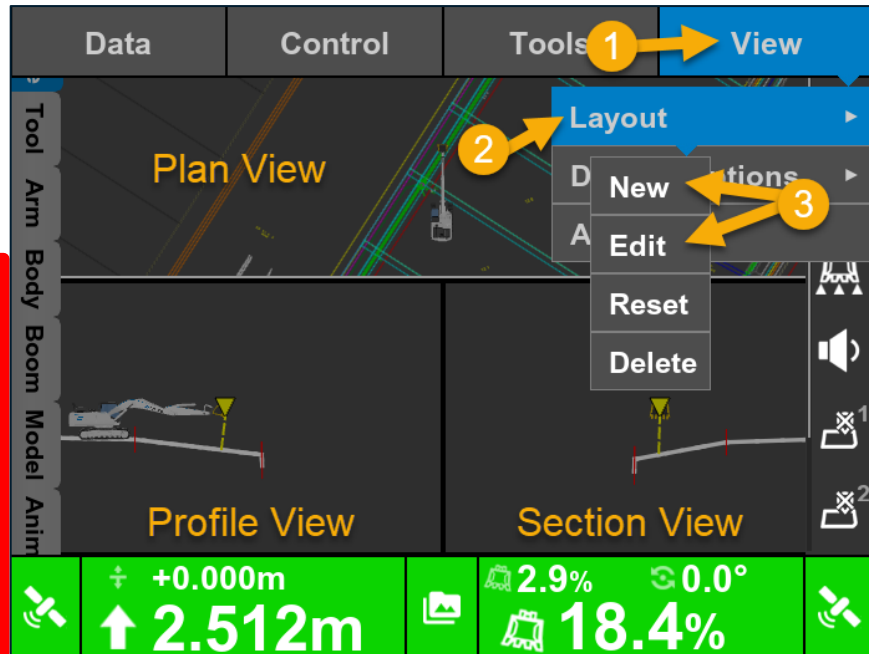

**Plan View** – top-down view of the machine, project file, layers and so forth.

**Profile View** – side view of the machine in relation to the surface.

**Section View** – operators view of the blade in relation to surface.

4. Select the desired layout configuration
5. Select a panel to select the view (the **Select a View** screen appears)
6. Select the desired view for the panel (**Plan View, Profile View, Section View, 3D View**)
7. Select **OK**
8. Select **OK** again. The main screen will be displayed with the selected layout and views

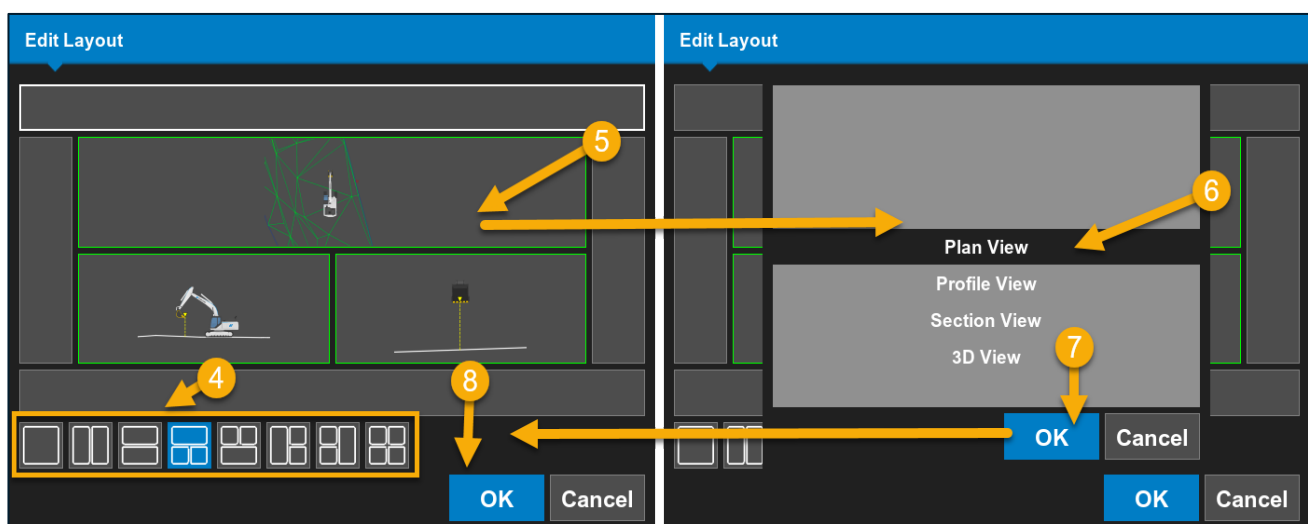

## Adding and Changing Display Text

The **Display Text** feature can be used to indicate some additional information to the operator.

To add a new line of text to the display:

1. Select and hold anywhere on the main screen. The **Context Pop-up Menu** appears.
2. Select **New Display Text**. The **Configure here** window will appear on the main screen which allows the operator to select from the different options.
3. Tap and hold on the **Configure** window to set the text as moveable or fixed. The option to hide the text is also available.

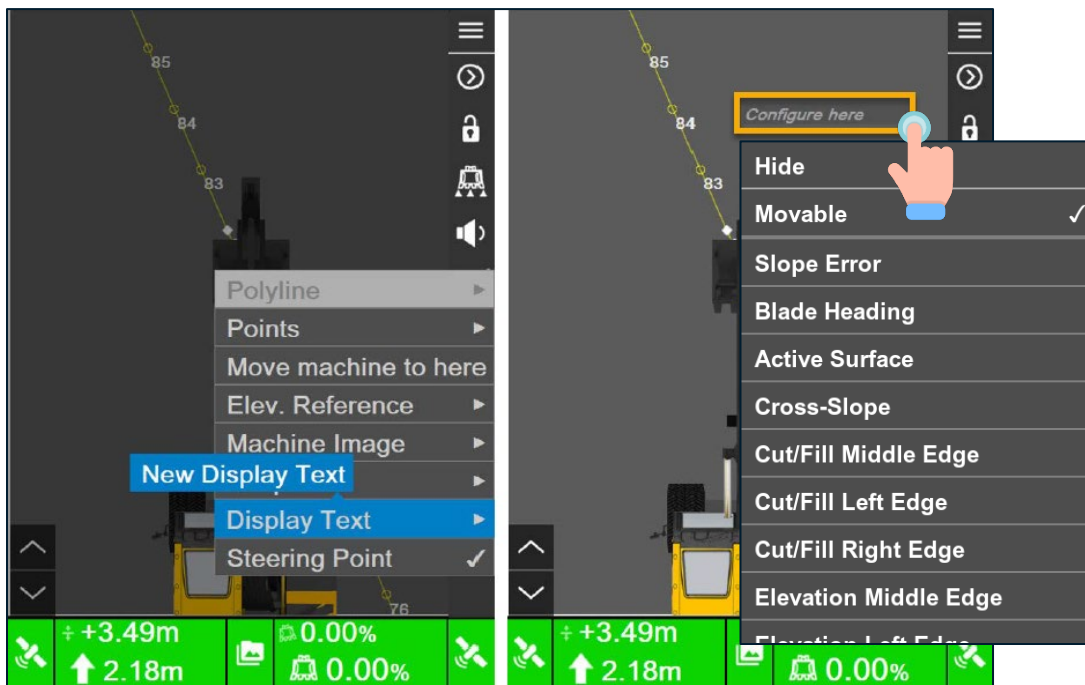

4. Tap and hold on the **Configure here** window to activate the desirable display text.

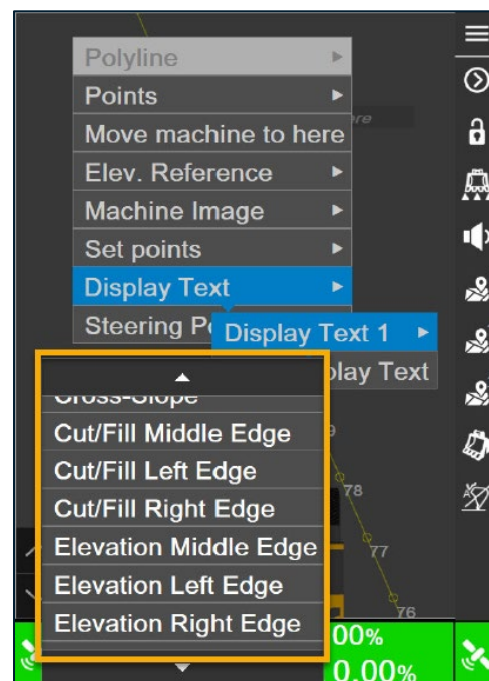

## Loading & Selecting a Site

### Selecting a Site

Press the Power/Menu Button (GX-55/GX-75) to open the main menu, then select **Data > Sites**.

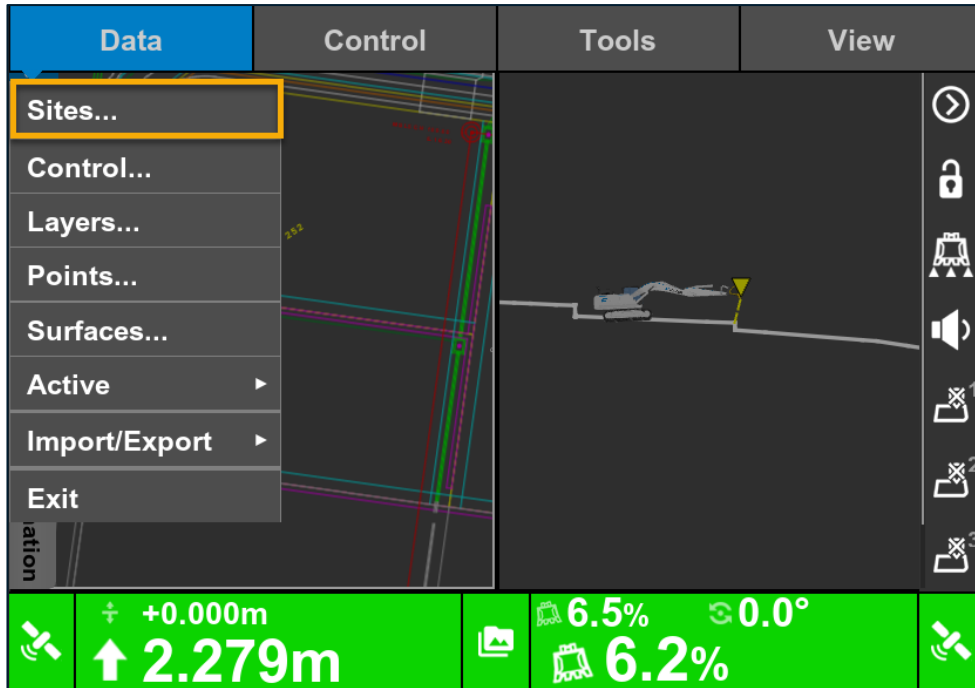

This will open a list view of all the sites on the control box, tap on the required site and press **OK**. The project will load on the screen.

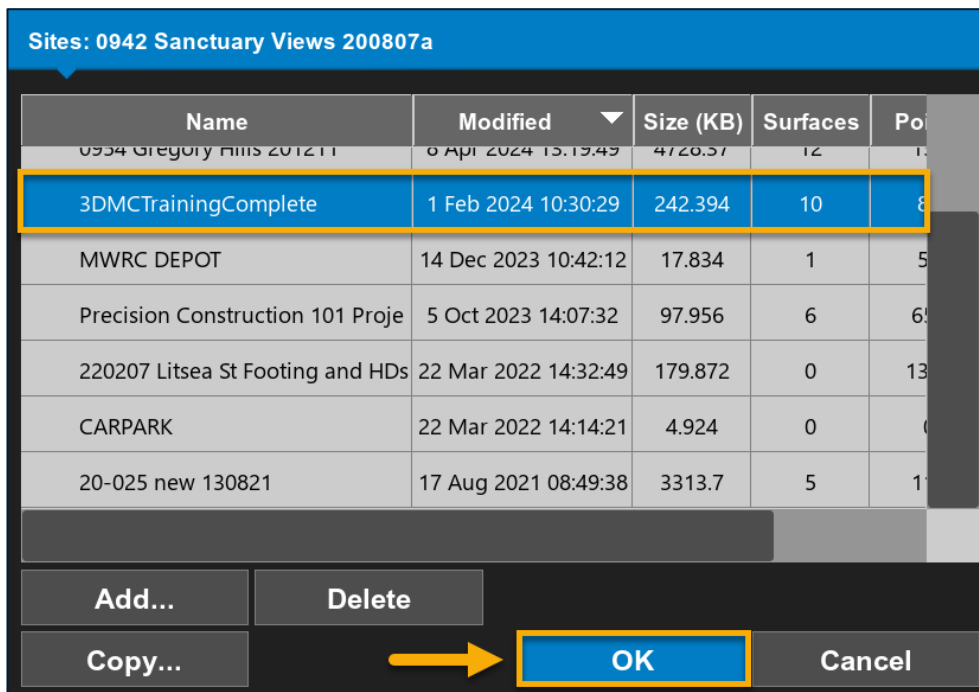

## Copying a Site

To copy a site from a USB storage device, insert the USB into the USB port. Go to **Data > Sites** and select **Copy**.

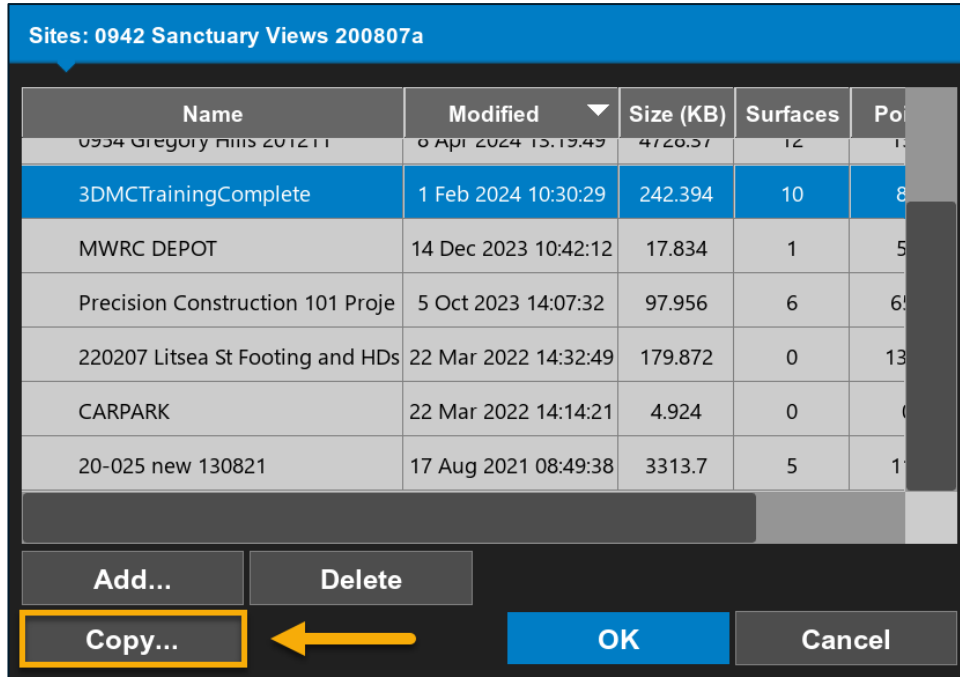

Select the pull-down option **From:** and set to **D:/ to 3DMC folder**. This will show a list of project files that are in the root directory of the USB (i.e. not hidden in a folder). Tap on the required site and press **Copy**.

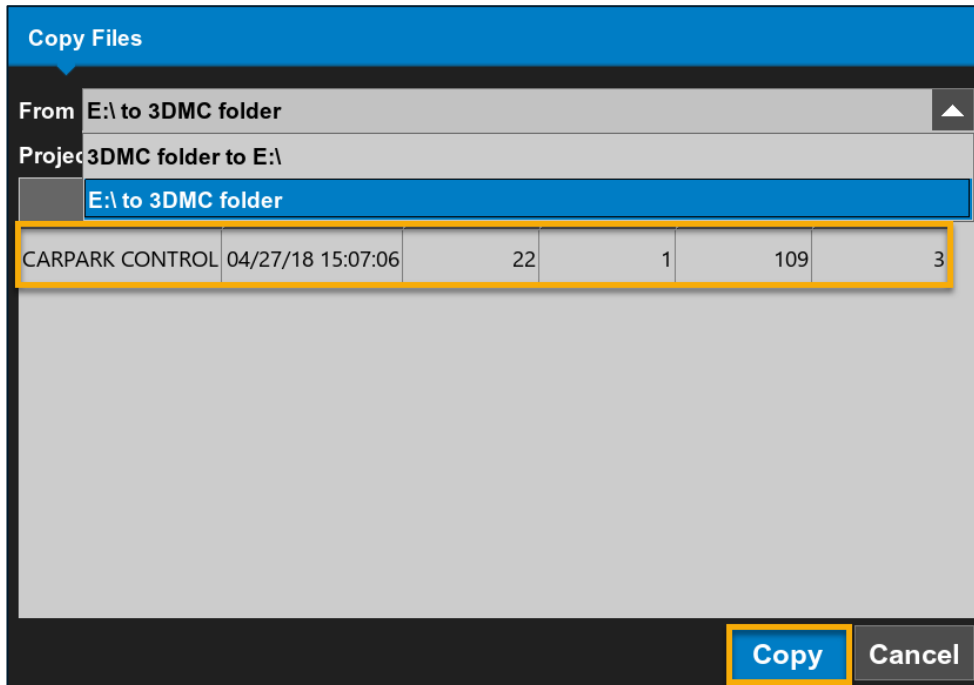

The file will be then listed in the Site Files list to be made active in the software.



## Selecting an Active Surface

To make a surface active, go to the **Data** menu and tap **Active**. A working surface can be selected from an **Alignment** or a **Surface** that is available in the Site.

Select the required surface by tapping **Surface** or **Alignment** and selecting from the list. The active surface will have a tick (✓) next to it.

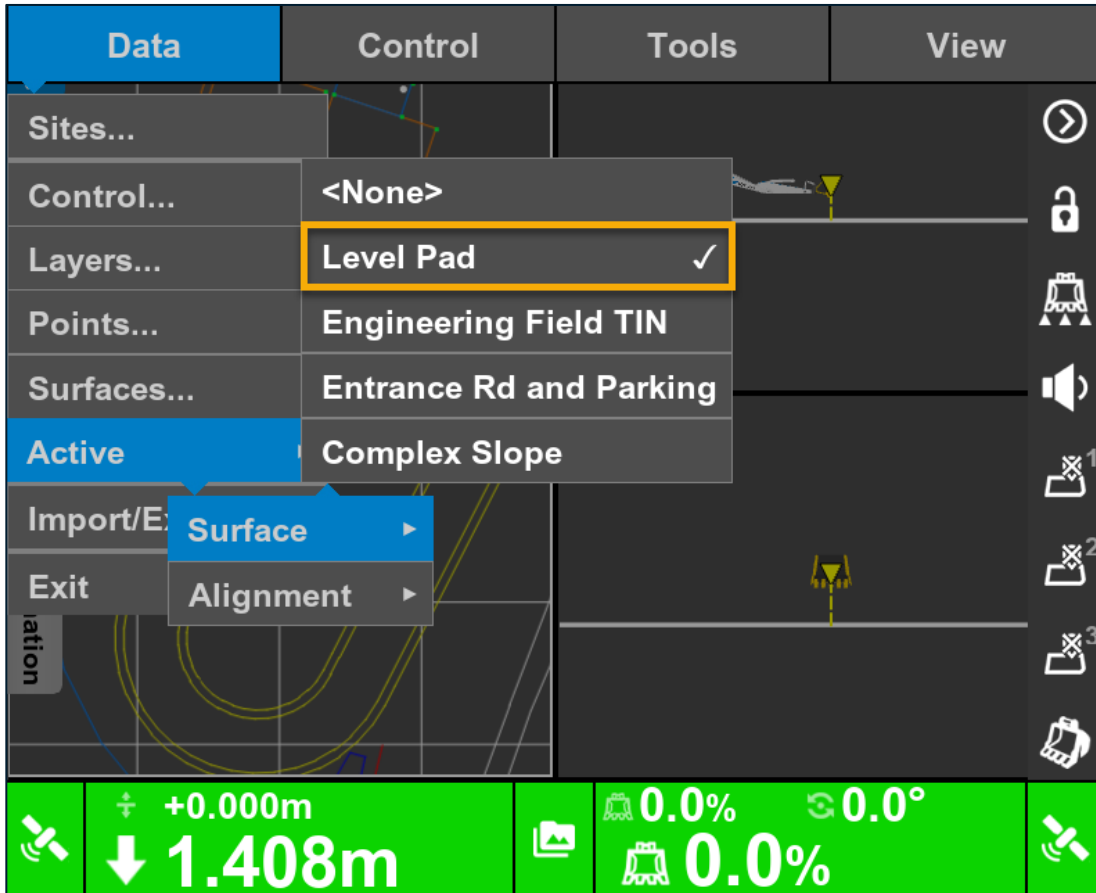

When the machine is outside the design surface it will show a message of **Out of Design** at the bottom of the screen. When it is over a surface it will show a cut/fill value and offset.

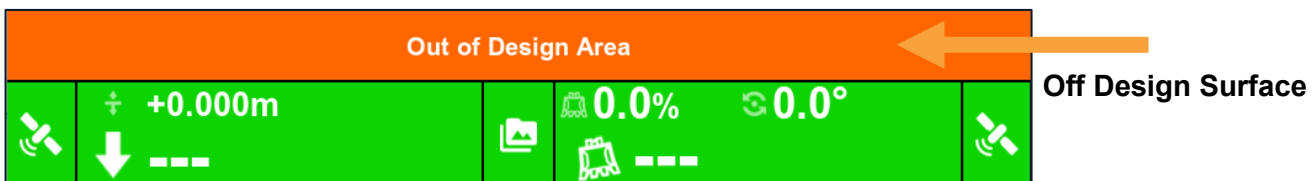

## Coordinate System Configuration

### Applying a Localization to the Project

To set up the project file on a localization, go to **Data > Sites > Control**. This will open up the control points list of the file where the localization adjustment is located.

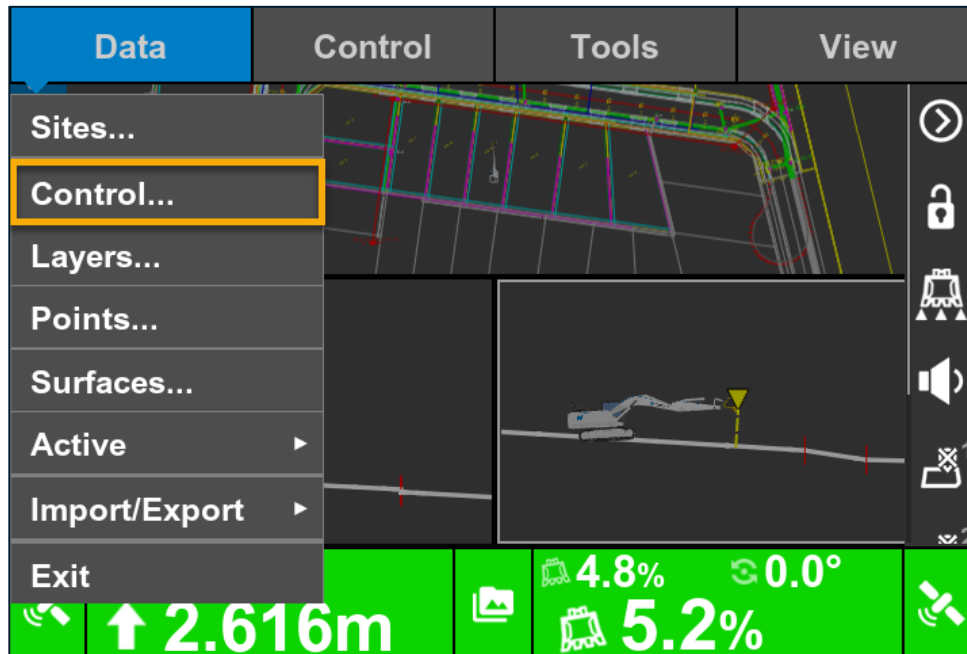

Ensure there are **H. Error** and **V. Error** adjustments next to 4 or more control points (this text should be in **Green**, signifying the localization is valid).

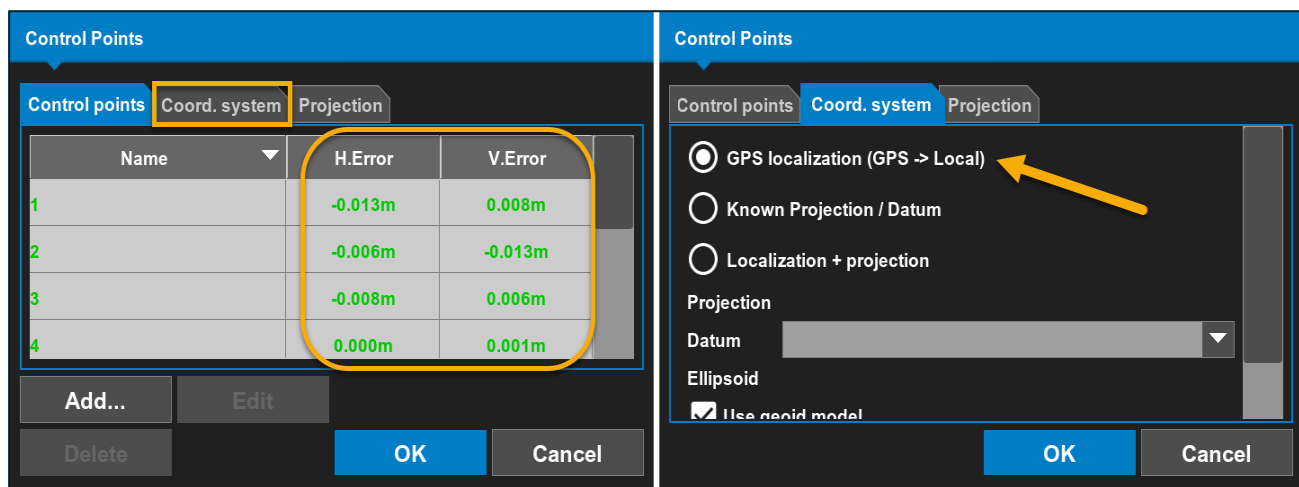

Select the **Coord. System** tab to check **GPS Localisation (GPS -> Local)** is selected. Tap **OK** to save the coordinate system settings and return to the main screen.



## Applying a Projection & Geoid to the Project

To set up the project file on a Projection & Geoid coordinate system, go to **Data > Sites > Control**. This will open the control points list of the file where the localization adjustment is located.

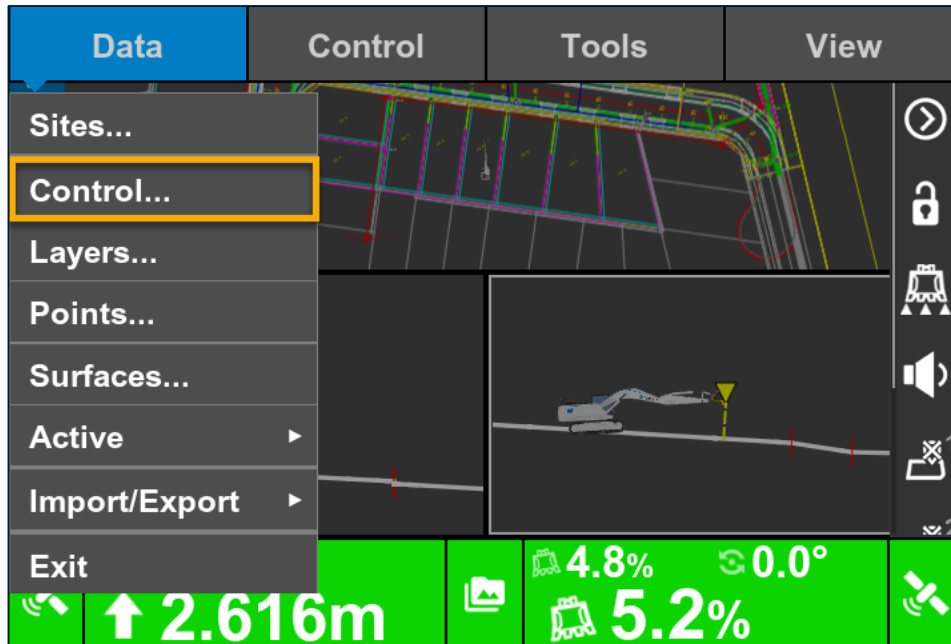

Select the **Coord. System** tab to check **Known Projection / Datum** and the **Use Geoid Model** (with the appropriate file chosen in the drop-down) tick box is selected (both options need to be selected to apply the projection and geoid coordinates).

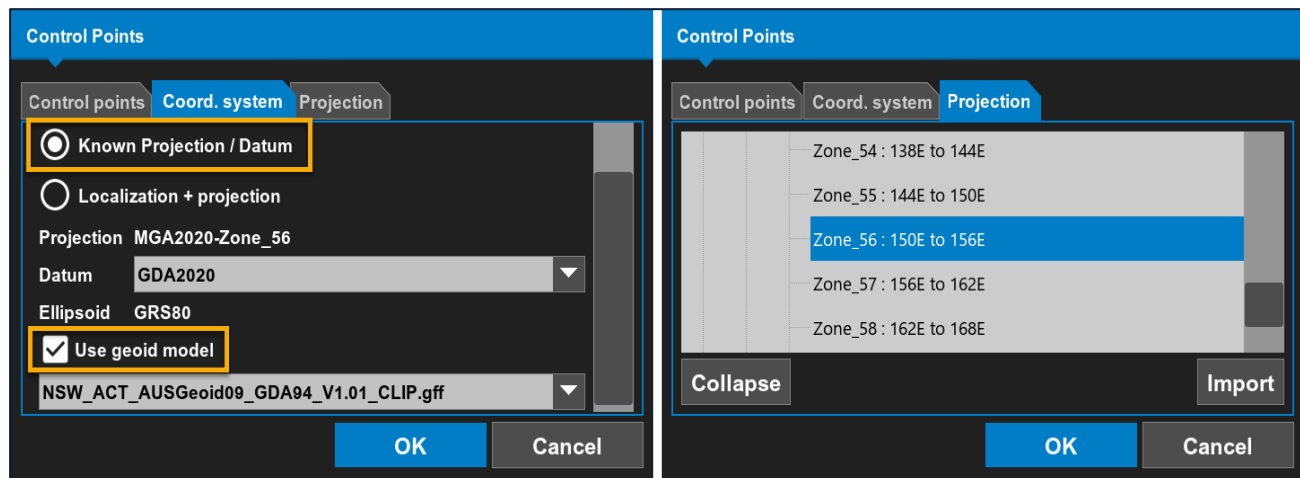

Select the **Projection** tab to assign the correct projection for the region you are working in. Select the **Coord. System** tab again to check all settings are correct (as per the left image above). Tap **OK** to save the coordinate system settings and return to the main screen.



## Elevation Set Point

### Applying a Vertical Offset

The operator can enter an offset value to **cut above or below** the active surface. To enter in an offset, tap the elevation control button at the bottom left.

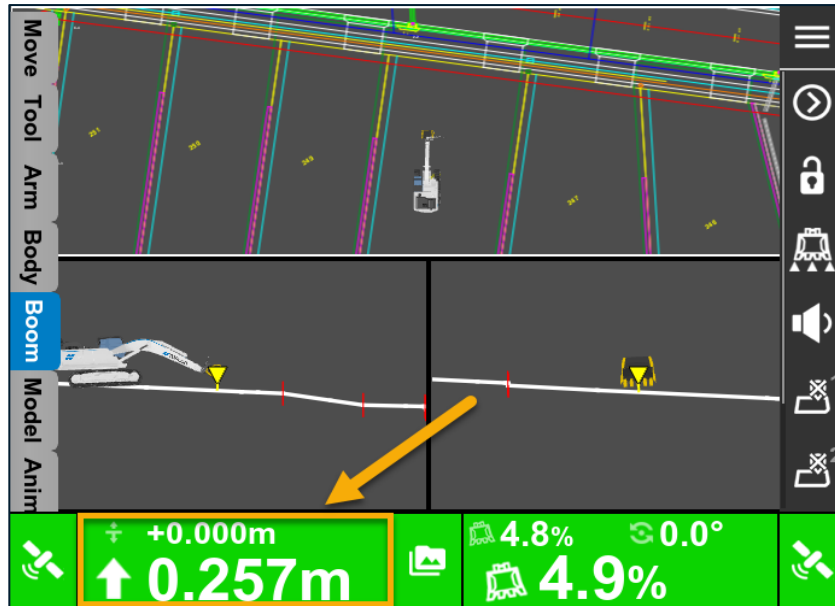

**Set Point:** Current set point or vertical offset to design surface. You can change it any time

**Cut/Fill:** Current cut/fill reading or distance to finish grade. This number continuously updates

Tap in the **Elevation set point** input, enter in the required offset, press **OK**.

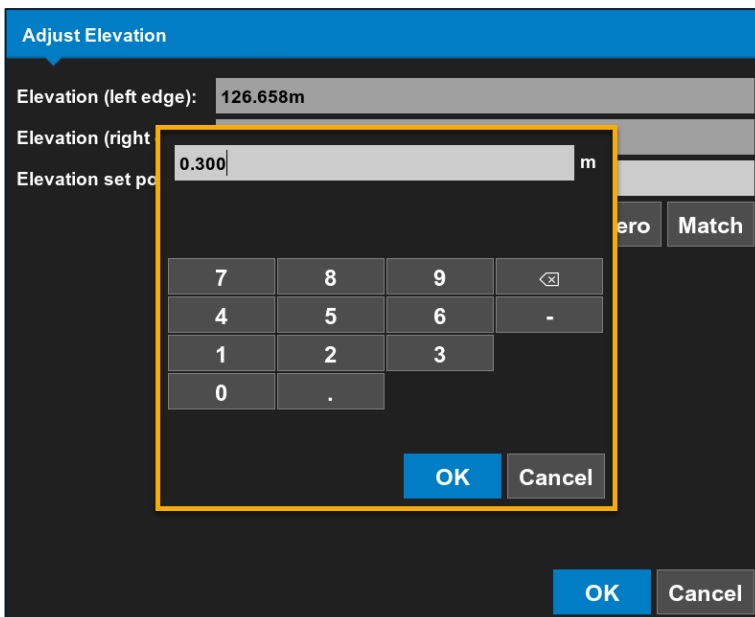

This will then show as an offset value in Elevation Control Button



## Steering to Line/Alignment

To use the **Steer to** function, we need to select the polyline first from the Plan View on the screen. This polyline becomes a **Steer to Polyline** and is highlighted on the screen.

1. Select the polyline by tapping and holding the desired polyline on the map
2. Select polyline from the pop-up menu
3. Select the **Steer to** function

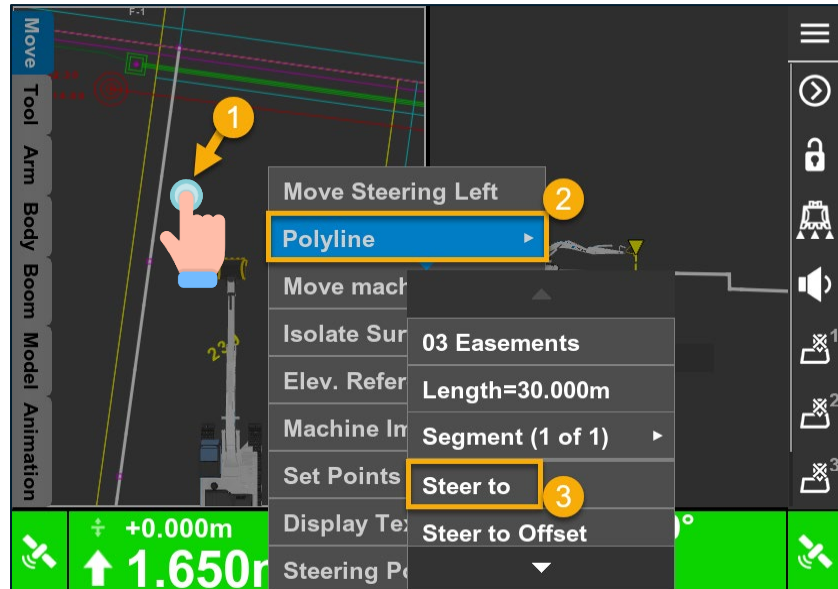

We need to know how far away the blade/attachment is off from the selected polyline. To know how far it is off:

1. Tap and hold anywhere on the Map Plan View
2. Select **Display Text**
3. Select **Display text 1**
4. Scroll down the text option list and select **Offset To Line**

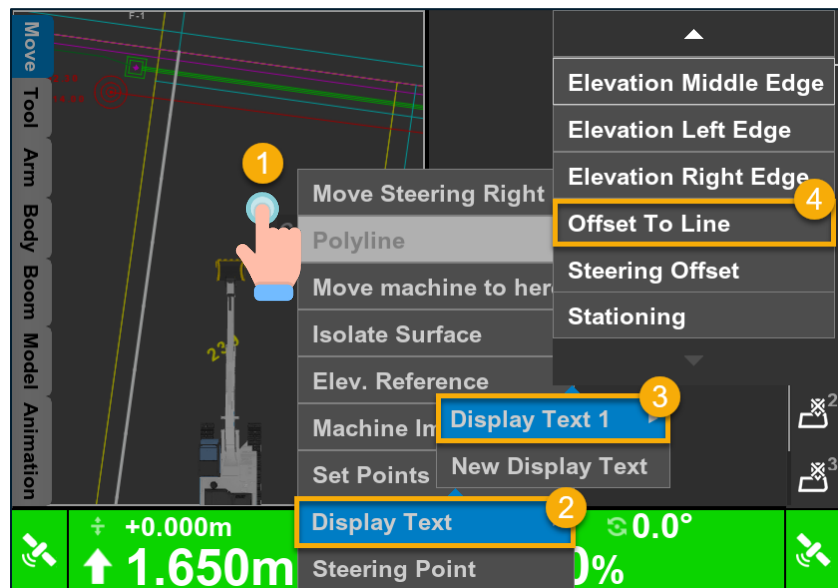

**Steering Indication Text** display pops up. This display text is moveable anywhere on the screen.

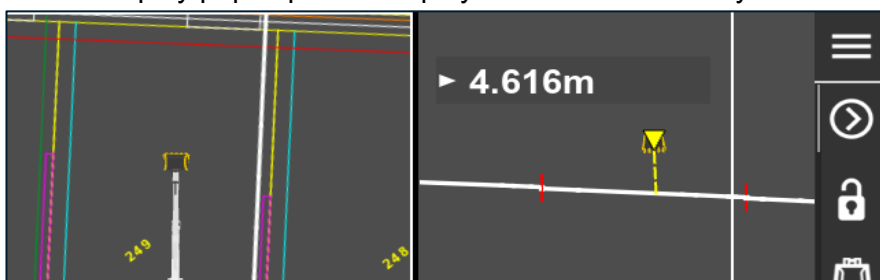

## Attachment (Bucket) Selection & Wear

### Editing/Selecting Attachments

To add a new attachment/bucket, or to edit an existing one, access the attachment wizard through **Control > Attachment**. Alternatively, the **Attachment Shortcut** button (bucket icon) in the shortcut's column will access the same attachments list.

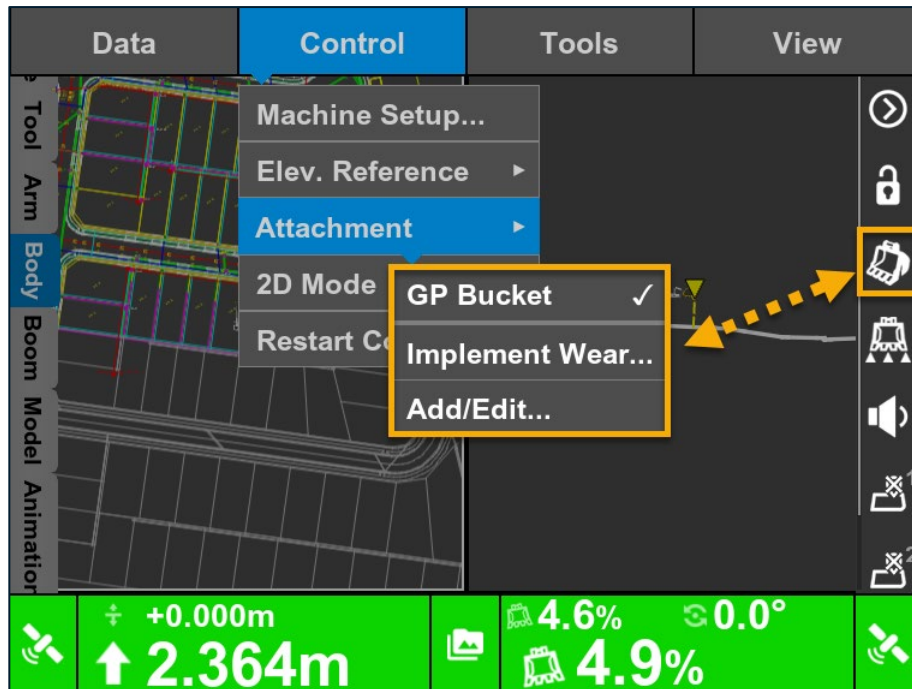

### Implement (Cutting Edge) Wear Adjustment

**Implement wear** can be modified without recalibrating the implement (bucket). As the cutting-edge wears overtime, new measurements can be adjusted in **Control > Attachment > Implement Wear**.

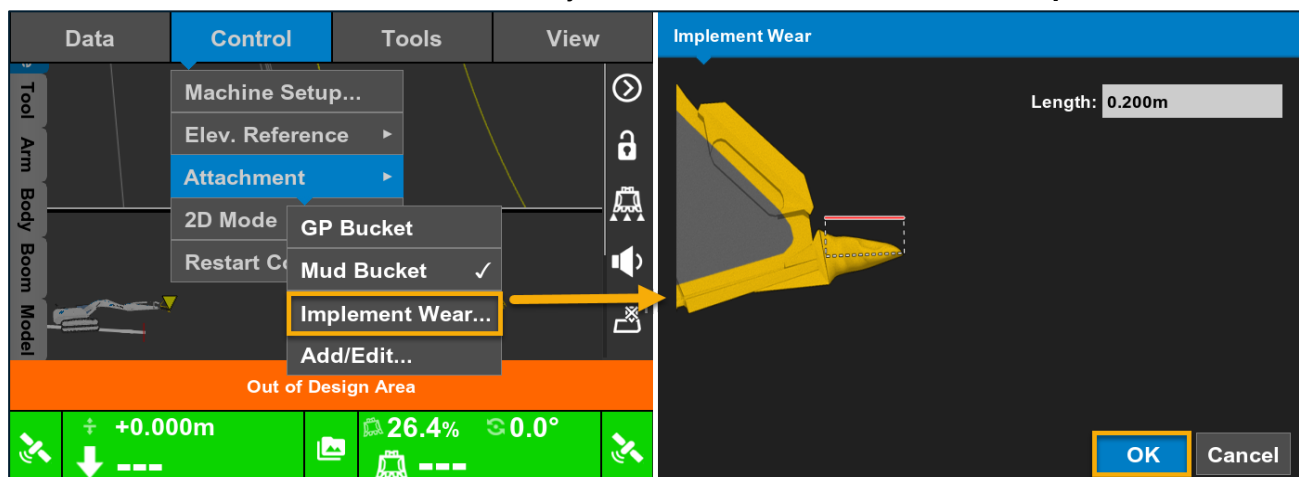

## Position Check

### Checking Blade or Bucket Position

Press the **Power** button on the display, then select **Tools > Position Check**. The **Position Check** screen will appear.

Select the **Point** (either **Left Edge**, **Right Edge** or **Middle**) on the blade or bucket of where you are physically measuring the benchmark onsite. Tap on **Measure** and 3DMC will check the blade/bucket position, displaying your position on the job.

- 1 Select **Alignment**
- 2 **Control** – Select a control point from the drop-down menu
- 3 **Points** – Tap the Points shortcut button to select a point
- 4 **Elevation** – Enter a known elevation to see the current **dZ**



## GNSS Configuration & Setup

### Setting up Radio/Network Configuration

This section describes how to perform system radio configurations. The radio type options are either **Topcon UR1 (UHF)** or **Direct Network Connection**.

Press the **Power** button on the display, then select **Tools > Configure Radios**.

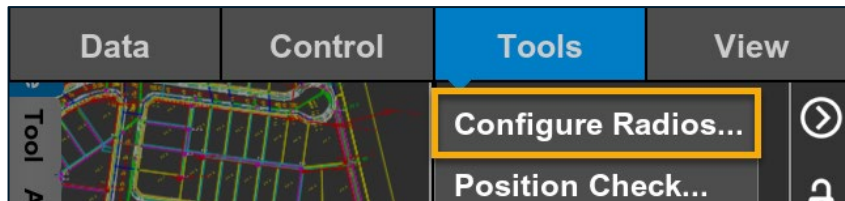

The **Configure Radios** screen appears for you to select the appropriate **Radio Type**, **Port** and **Format**, then select **Configure**. The **Radio Parameters** screen appears for you to select the radio configuration information and channel that matches the channel of the base station.

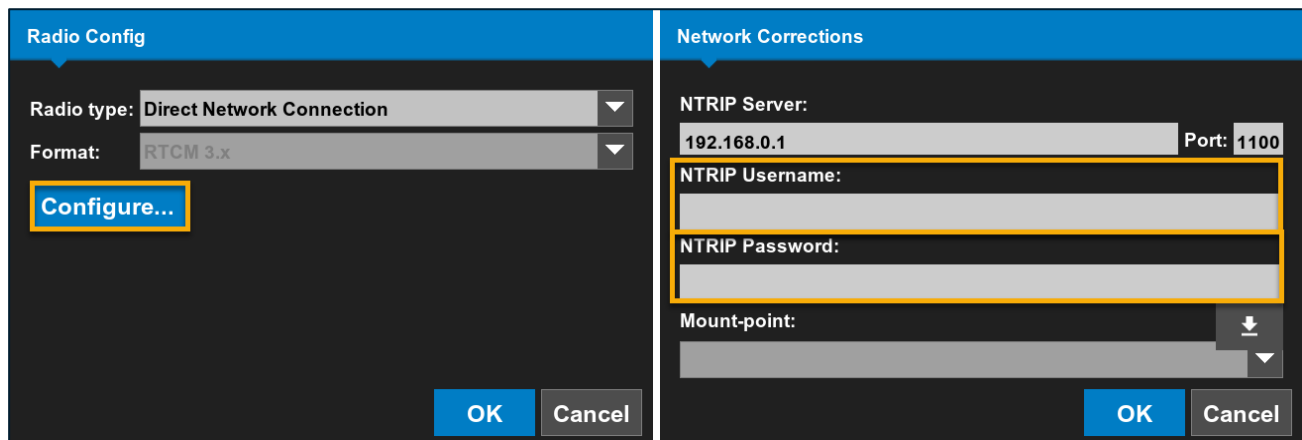
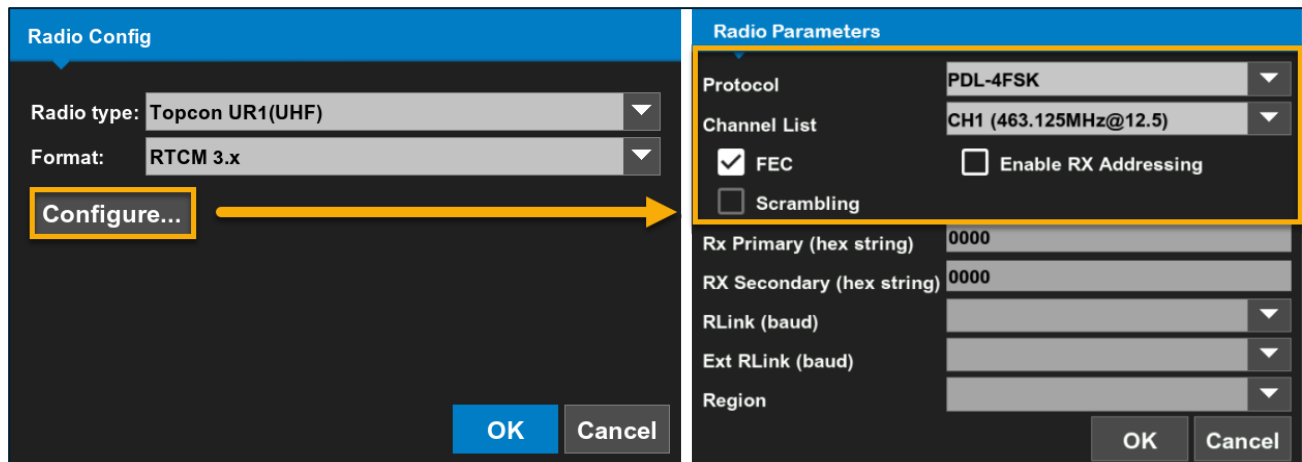

Select **OK** to save settings. Change the radio type to **Direct Network Connection** to connect to a network base station. Select **Configure** and here you can add the correct **NTRIP Server**, **Username**, **Password** and **Mount-Point**. Select **OK** to save settings and return to the main screen.



## GNSS Information and Status

Select the **Elevation Sensor Status** indicator/button. The **GNSS Info** screen will display.

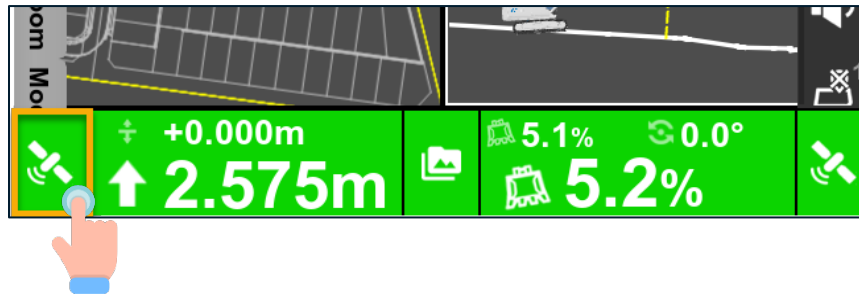

Select tabs to display additional GNSS information.

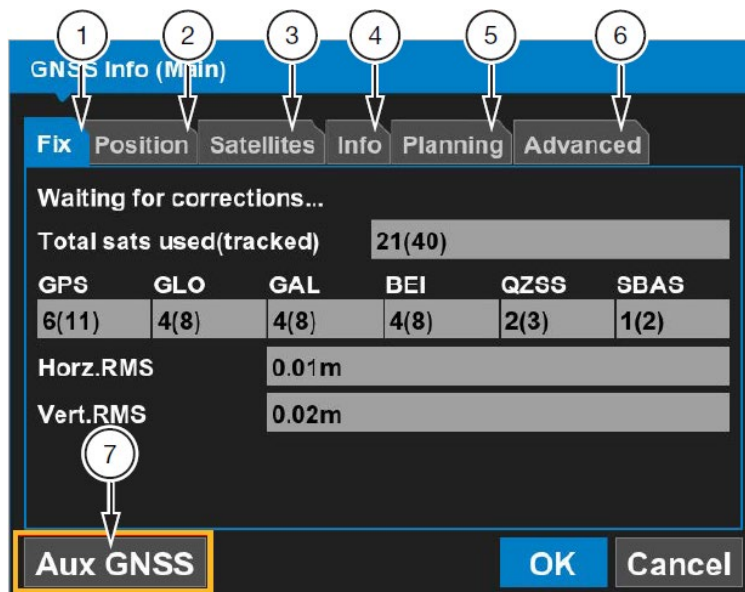

ID	TAB	INFORMATION
1	Fix	GNSS status and quality
2	Position	Cutting edge position
3	Satellites	Monitor visible and used satellites
4	Info	View receiver information or reset receiver
5	Planning	Satellite estimated accuracy information. The red vertical line marks the current time
6	Advanced	GNSS options to enable/disable specific satellite constellations, multipath reduction, and relative antenna offset
7	Aux GNSS	Displays AUX GNSS information screen



## LPS Interface & Setup

### LPS Interface and Home/Search Functions

When using a Total Station for 3D positioning, the **2D/3D Elevation Mode and Status Indicator/Button** will feature a Total Station Icon (1).

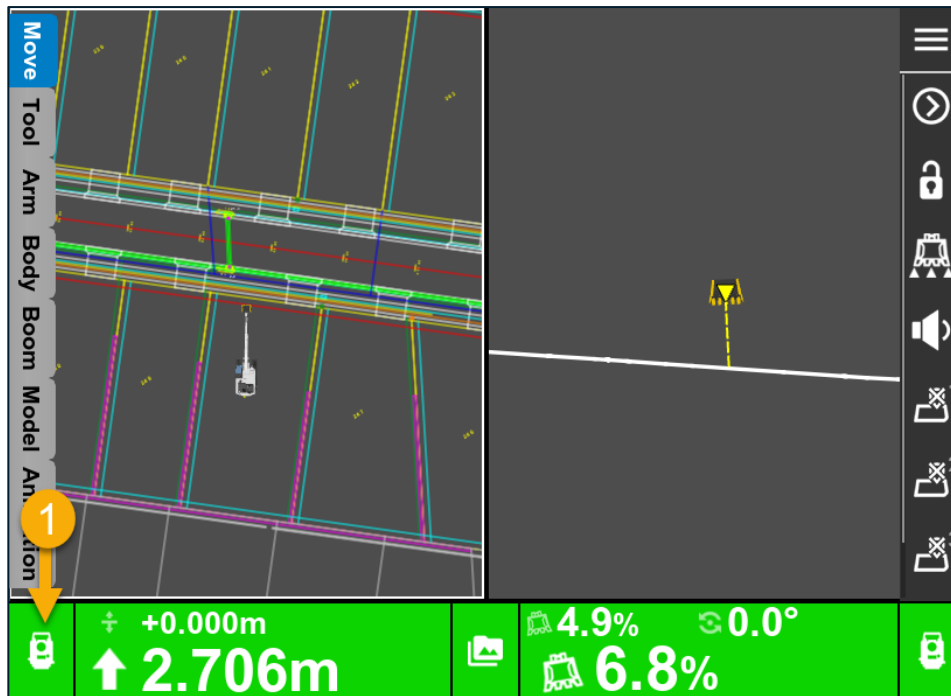

Select the Total Station Icon (1), go to **Position Tab** for the machine position information and **Tracking Status**. From the **Search** screen, you are able to navigate the Total Station towards the prism and use the home locating function.

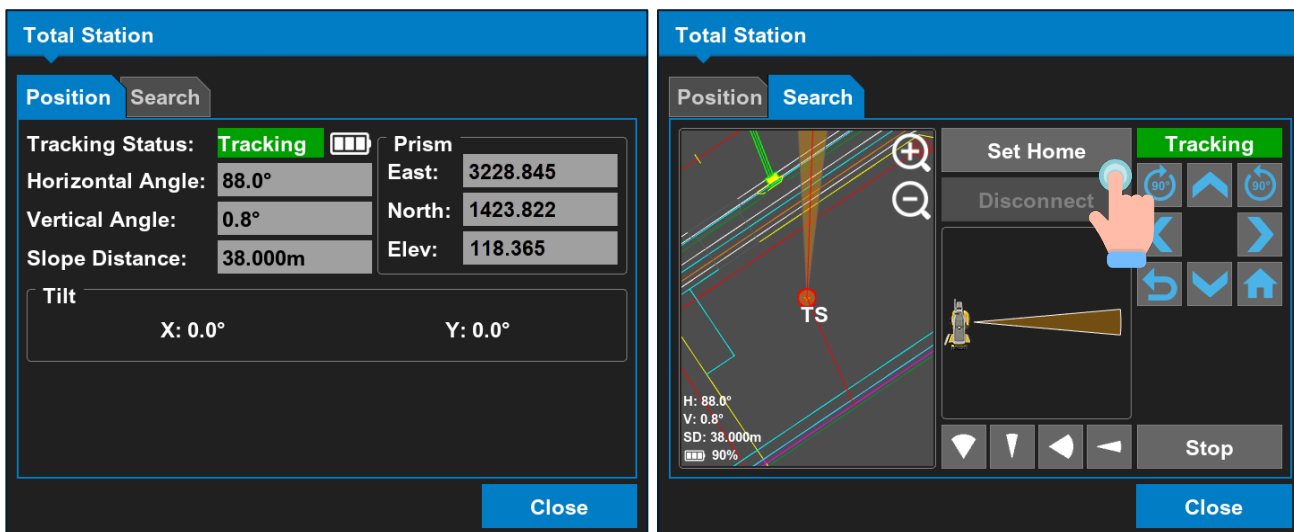

#### Set Home

**Set Home:** Allows you to set a known location for the Total Station to start searching for the prism. If the prism is found, the total station locks on the prism and starts tracking (usually set at the start of a pass or run).



## Initial Instruction Record

Please fill out the below details once the initial handover instruction has been completed by an Aptella Representative.

<b>WO Number</b>	
<b>Operator Name</b>	
<b>Email Address</b>	
<b>Phone Number</b>	

<b>Operator Name</b>	
<b>Email Address</b>	
<b>Phone Number</b>	

<b>Operator Name</b>	
<b>Email Address</b>	
<b>Phone Number</b>	

<b>Operator Name</b>	
<b>Email Address</b>	
<b>Phone Number</b>	



## Notes

Please use the space below to add any additional personalized notes.



## Notes

Please use the space below to add any additional personalized notes.



## Notes

Please use the space below to add any additional personalized notes.



## Notes

Please use the space below to add any additional personalized notes.



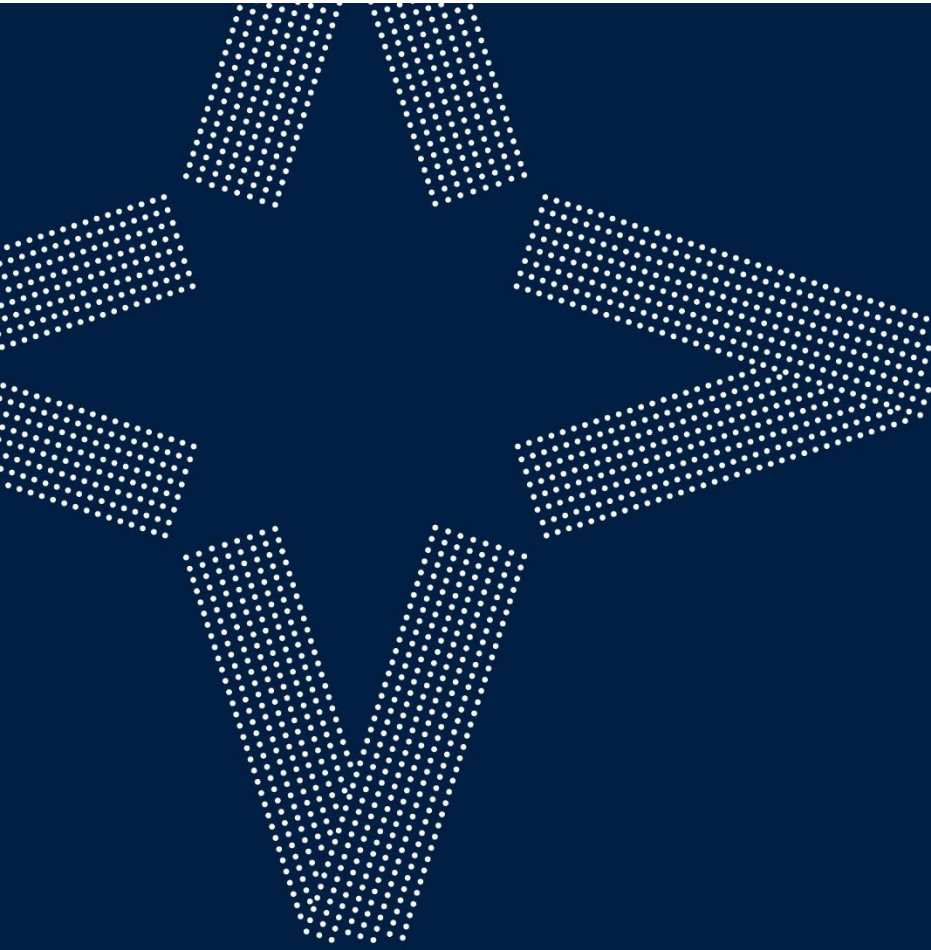

# Aptella

AUTOMATION +  
POSITIONING TECH

